

Extra page

HSW clamping head

A116547.0003A

EN

1 General

1.1 Information about this extra page

This extra page enables you to work safely and efficiently with the product.

This extra page is part of the product and must be kept in a location directly beside the product that is accessible to the personnel at all times. The personnel must have read this extra page carefully and understood its contents before starting any work. The basic requirement for safe work is compliance with all stipulated safety notices and work-related instructions on this extra page.

If the product is passed onto a third party, this extra page must accompany it.

Illustrations on this extra page are there to facilitate a basic understanding, and may differ from the actual design configuration of the product.



WARNING

Serious injuries caused by individual products or by inappropriate combinations of them!

- In addition to this extra product page, all documents apply to products in this combination.
- Read and pay attention to all documents for individual products and this combination.

1.2 Scope of delivery

The scope of delivery of this product includes:

- HSW clamping head
- Attachment

Additionally needed and included as optional items in the scope of delivery:

- Clamping device
- Dressing ring
- Dressing pin

2 Use

2.1 Use-related safety



WARNING

Serious injuries caused by unskilled staff when dressing the product!

- The product must only be dressed by skilled staff from the relevant specialist field.



WARNING

Serious injuries caused by tools and items of test equipment being ejected centrifugally!

- Before dressing the product, ensure that all tools and items of test equipment are removed from the working area of the machine.



WARNING

Serious injuries can be caused if the machine tool starts up accidentally!

- dressing must only be performed on a machine with an enclosed working area.
- Before dressing, close all safety doors or hoods on the machine tool.



WARNING

Serious injuries can be caused by using the wrong dressing ring / dressing pin!

- Only use the dressing ring / dressing pin with the right clamping diameter.

2.2 Specifications for using the product

The next section defines the limits for using the product and these must never be exceeded.



In addition to these operating instructions, also read and follow the operating instructions for the relevant clamping device.

In addition, the limits of use for the clamping device also apply [see operating instructions for the clamping device].

2.2.1 Actuating force

The maximum axial actuating force for the product $F_{ax\ max}$ is 70 kN.

2.2.2 Workpiece clamping length

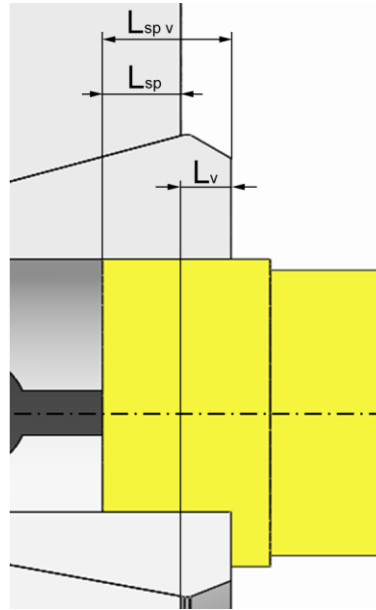

Without exception, never go below the total clamping length $L_{sp\ v}$ of the workpiece, which measures at least 3 mm.

At a clamping diameter of 128 mm up to and including 152 mm, the total clamping length $L_{sp\ v}$ of the workpiece must be at least 12 mm.

Specifically with axial tension clamping devices, pay attention to relative movement in axial direction.

2.2.3 dressing dimensions for the product

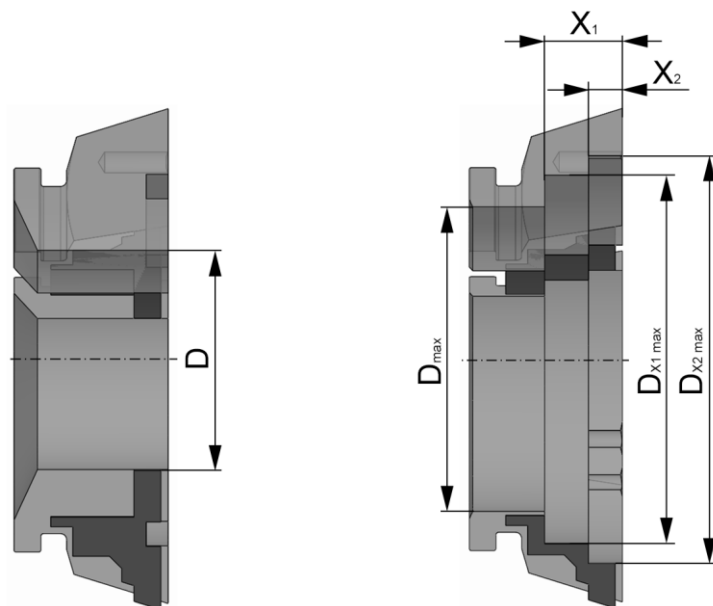

Do not change the total length of the product, measuring 63 mm.

Dressing the product to its full length should only occur up to a maximum diameter of 125 mm.

Whenever a head bore is produced, in other words an offset clamping bore, this must be dressed to a length of at least 10 mm otherwise secure clamping action cannot be assured. The dressing length is measured from the face end of the product.

From a dressing diameter of > 125 mm, part of the vulcanization is removed during the dressing process. This weakens the joining force between the segments. Therefore, when dressing clamping diameters > 125 mm, never exceed the limits defined in the following table.

Dressing diameter D [mm]	Dressing length X_1 [mm]		Dressing length X_2 [mm]	
	minimum	maximum	minimum	maximum
> \varnothing 125 and $\leq\varnothing$ 128	10	32	-	-
> \varnothing 128 and $\leq\varnothing$ 151	19	32	-	-
> \varnothing 151 and $\leq\varnothing$ 152	-	-	19	-
> \varnothing 152 and $\leq\varnothing$ 167	-	-	10	14

Table 1: Dressing dimensions

The external diameter of the turned groove cannot be used as a clamping diameter.

2.3 Dressing the product

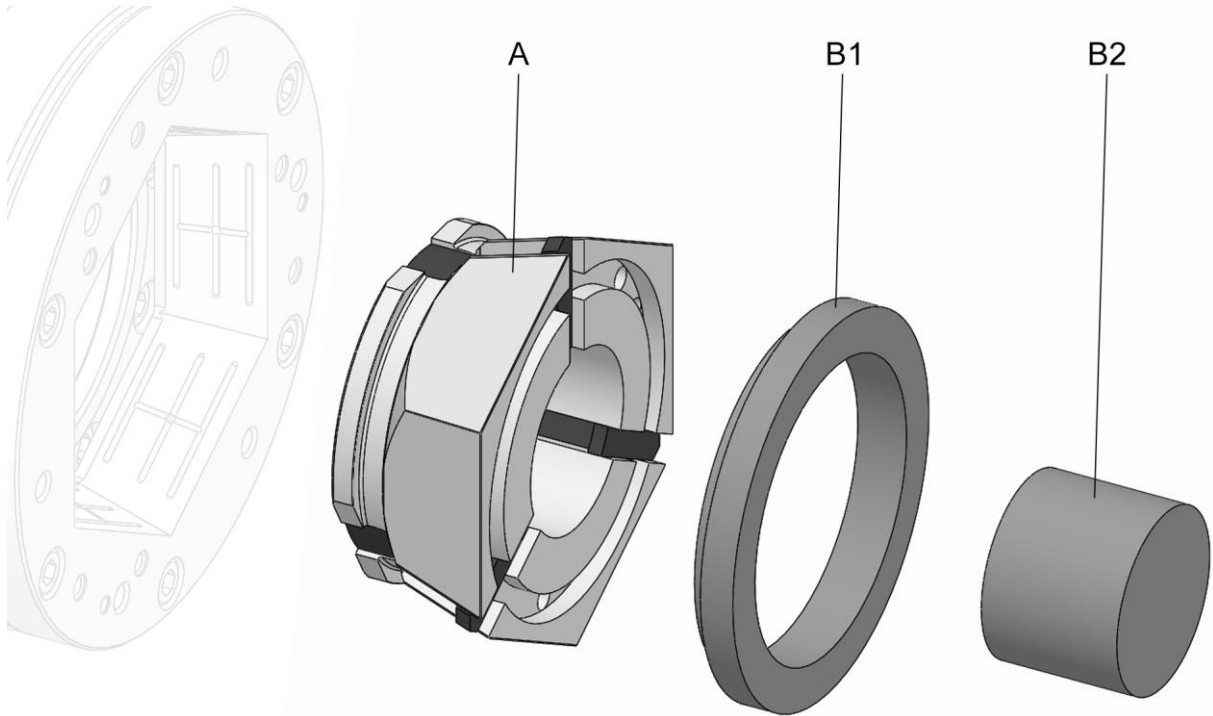

- A HSW clamping head
- B1 Dressing ring
- B2 Dressing pin

The product must only be machined within the specified limits [see »Specifications for using the product« chapter].

The clamping surface and the face end of the product are not hardened.

There are two ways of dressing a product:

- Machining a head bore with the help of a dressing pin. This must share the same external diameter as the nominal diameter of the HSW clamping head.
- The clamping bore is machined with the help of a dressing ring. This is specifically designed for the corresponding HSW clamping head.



INFORMATION

Installation / removal of the product is described in the operating instructions for the clamping device.



In addition to these operating instructions, also read and follow the operating instructions for the relevant clamping device.

1. Install the HSW clamping head [see operating instructions for the clamping device].

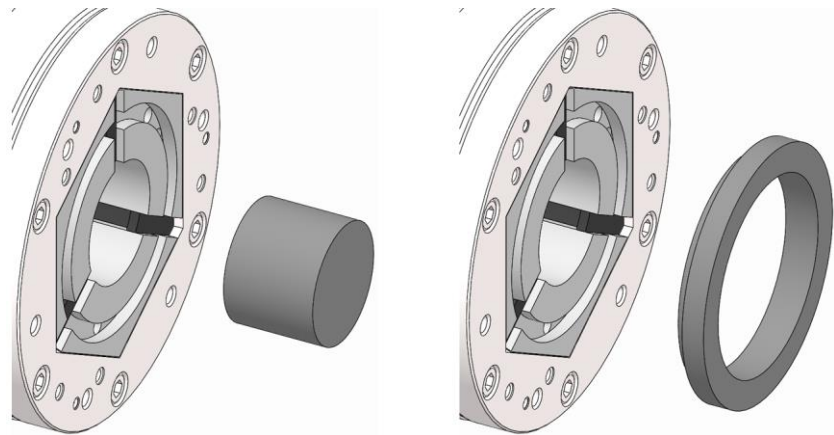

2. Install the dressing pin in the clamping device to prevent it from getting damaged when the HSW clamping head is getting machined. and/or, install the dressing ring firmly home in the turned groove in the HSW clamping head.

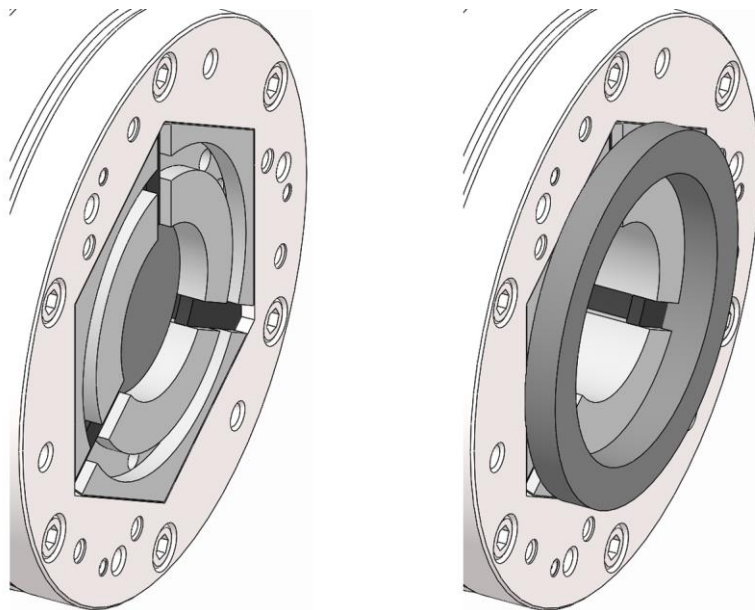

WARNING

Crushing injuries to hands / fingers if dressing pin / dressing ring is installed incorrectly!

- Do not place hands / fingers between dressing pin / dressing ring and clamping element.
- Never reach into the clamping area.

3. Clamp the dressing pin / dressing ring to the maximum axial actuating force specified [see »Specifications for using the product« chapter].

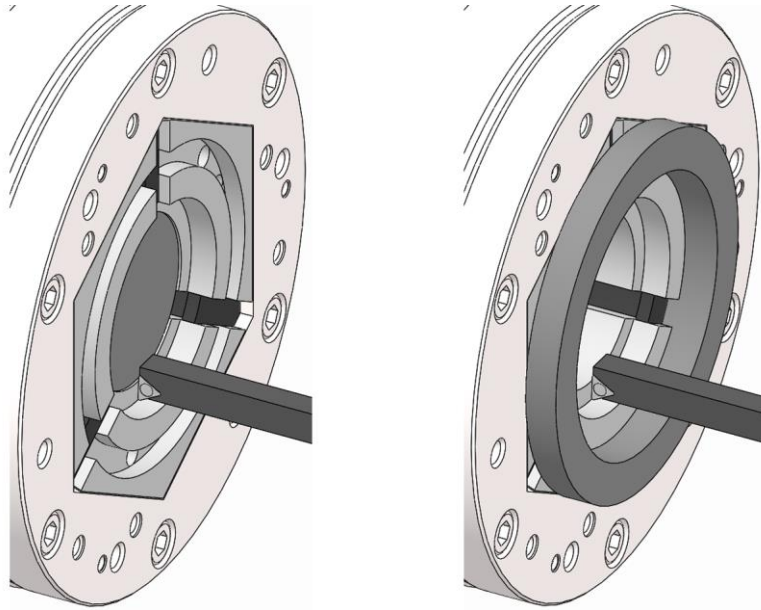

WARNING

Serious injuries caused by exceeding the specified limits!

- Never exceed the specified limits [see »Specifications for using the product« chapter].
- The dressing pin / dressing ring must not be damaged during the dressing process.



WARNING

Serious injuries caused by not clamping the dressing ring while dressing the product!

- Only dress the HSW clamping head in dressed condition.



NOTE

Damage to materials caused by dressing the product without lubricant!

- Always use cooling lubricant when dressing the product.

4. Dress the HSW clamping head to the desired dimension. Ensure that you do not exceed the specified limits [see »Specifications for using the product« chapter].

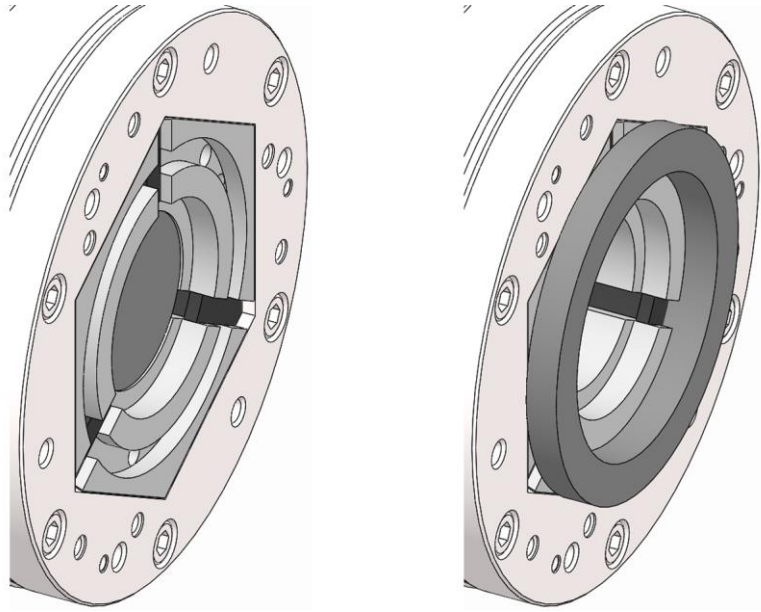

5. Release tension on the dressing pin / dressing ring. To do this, if necessary secure the dressing pin / dressing ring to prevent it from falling out.

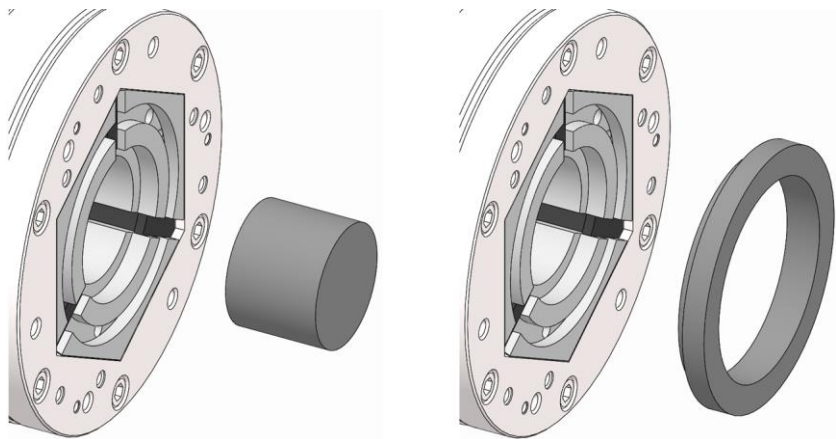

6. Remove the dressing pin from the clamping device. And/or remove the dressing ring from the HSW clamping head.

3 Annex

3.1 Contact

The following hotlines are available to you for orders, schedule tracking and emergencies.

Order hotline

Ordered quickly, supplied swiftly. Just phone:

+49 7144. 907-333

Tracking hotline

Current status of your order? Just call:

+49 7144. 907-222

24 hour emergency phone line

Has a system crash occurred, or some other technical emergency?

Our experts are there for you around the clock:

+49 7144. 907-444

For advice or help, you can contact the sales partners and service staff listed in www.hainbuch.com.



HAINBUCH GMBH · SPANNENDE TECHNIK

Postfach 1262 · 71667 Marbach / Erdmannhäuser Strasse 57 · 71672 Marbach · Germany

Tel. +49 7144.907-0 · Fax +49 7144.18826 · verkauf@hainbuch.de · www.hainbuch.com

24 hour emergency phone line + 49 7144.907-444

03.2023 · A116547.0003V EN · Technical modifications reserved